



Sovitron Interior Pvt.Ltd.



<b>Model Name</b>	Rectangle Ring Pendant / DLARRECDPD-70
<b>Description</b>	Architectural Light

Technical description	Image
-----------------------	-------

<b>Dimension</b>	L=Customised H=60/90/95mm
<b>Frame</b>	Aluminium
<b>Color Tempertaure</b>	3000K
<b>Power</b>	70 W
<b>Total Luminous Flux</b>	6300 lm
<b>Efficacy</b>	90 lm/W
<b>IP rating</b>	50
<b>Color Rendering</b>	≥80
<b>Mounting</b>	Pendant
<b>Optics</b>	White Opal Diffuser
<b>Dimming</b>	NON-Dimmable
<b>Operating Voltage</b>	220-240 VAC
<b>Standard Lifetime</b>	L70 minimum at 50,000 burning hours

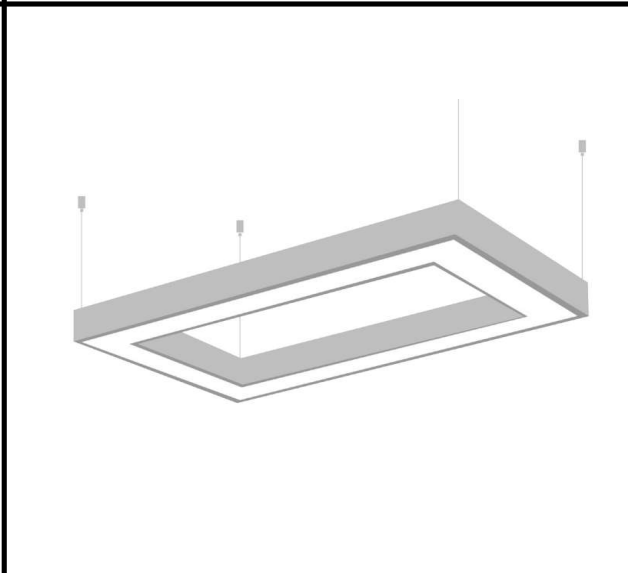

Dimension diagram
-------------------

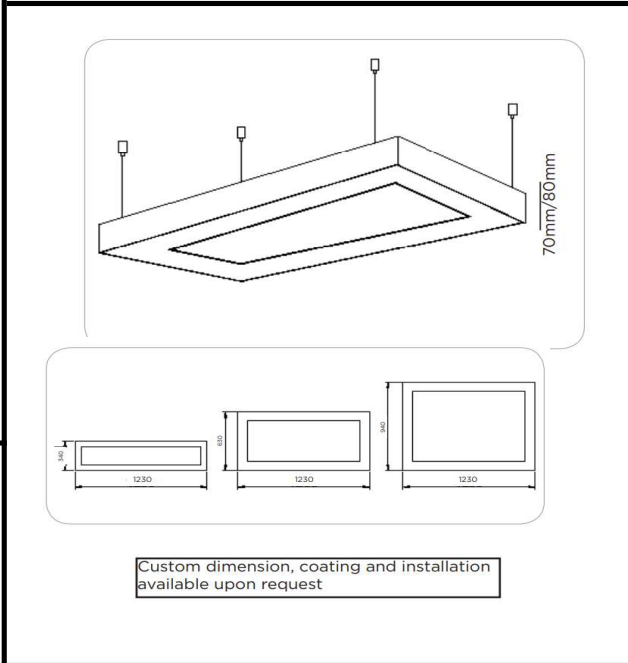

**Remarks:-**

**Address: Plot #7 Saroorpur-Nangla Industrial Area,Ballabgarh-Sohna Road,Faridabad-121005**  
**Email: info@sovitron.com**